



BANCO  
RECEPTION

RECEPTION  
COUNTER

DESK

**SCS**

SISTEMI DI ARREDO PER LA DISTRIBUZIONE

## BANCO CASSA RECEPTION / RECEPTION COUNTER

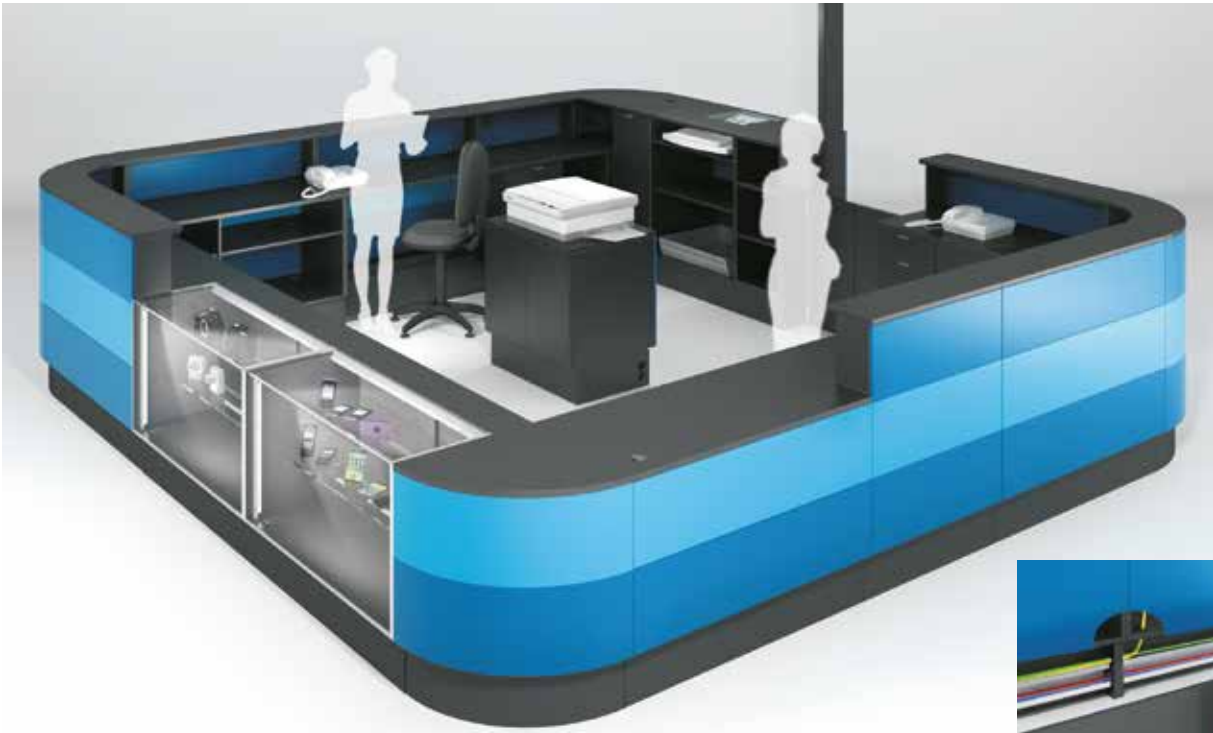

Canalizzazione elettrica  
Trunking



IL BANCO CASSA RECEPTION, GRAZIE ALLE SUE LINEE MORBIDE ED ELEGANTI E ALLA SUA MODULARITÀ, PUÒ ESSERE IMPIEGATO SIA NELLA PICCOLA CHE NELLA GRANDE DISTRIBUZIONE ORGANIZZATA.

IL BANCO CASSA RECEPTION PUÒ ASSUMERE LA FUNZIONE DI DESK O ZONA CASSA, ANCHE PER FORME DI PAGAMENTO INNOVATIVE STILE I-CASH MANAGEMENT.

THE RECEPTION COUNTER, THANKS ITS FLOWING AND ELEGANT LINES AND ITS MODULARITY, CAN BE USED BOTH FOR GDO AND RETAILERS.

RECEPTION COUNTER CAN HAVE BOTH THE FUNCTION OF DESK AND CHECKOUT AREA, ALSO FOR INNOVATIVE PAYMENT FORM AS I-CASH MANAGEMENT.



# BANCO CASSA RECEPTION / RECEPTION COUNTER





# BANCO CASSA RECEPTION / RECEPTION COUNTER

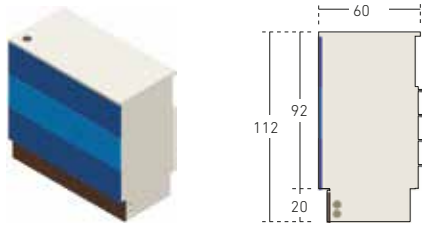

## ELEMENTI H 112 MODULE H 112

### ELEMENTO CON VANI MODULE WITH SHELVES



COLOR	H	P	L
A	112	60	40
G	112	60	40



COLOR	H	P	L
A	112	60	80
G	112	60	80

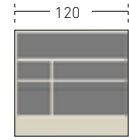

COLOR	H	P	L
A	112	60	120
G	112	60	120

### ELEMENTO CON ANTE MODULE WITH DOORS



COLOR	H	P	L
A	112	60	40
G	112	60	40



COLOR	H	P	L
A	112	60	80
G	112	60	80

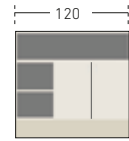

COLOR	H	P	L
A	112	60	120
G	112	60	120

### ELEMENTO CON CASSETTI MODULE WITH DRAWERS



COLOR	H	P	L
A	112	60	40
G	112	60	40



COLOR	H	P	L
A	112	60	80
G	112	60	80

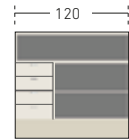

COLOR	H	P	L
A	112	60	120
G	112	60	120

### ELEMENTO CON CASSETTO PER CHIODI ANTITACCHEGGIO MODULE WITH NAILS SHOPLIFTING DRAWER



COLOR	H	P	L
A	112	60	80
G	112	60	80

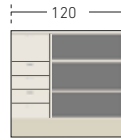

COLOR	H	P	L
A	112	60	120
G	112	60	120

### ELEMENTO CON CASSETTI ED ANTE MODULE WITH DRAWER AND DOORS

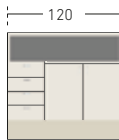

COLOR	H	P	L
A	112	60	120
G	112	60	120

### ELEMENTO CON VETRINA ILLUMINATA MODULE WITH GLASS DISPLAY LIGHTED

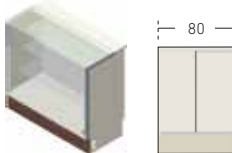

COLOR	H	P	L
A	112	60	80
G	112	60	80

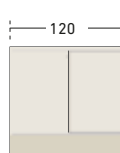

COLOR	H	P	L
A	112	60	120
G	112	60	120

#### VETRINA H112: POTENZA ASSORBITA POWER CONSUMPTION

H	P	L	WAT
112	60	80	2 LAMPADE DA 21 WAT + 1 DA 14 WAT = 56 2 LIGHT 21 WAT + 1 LIGHT 14 WAT = 56
112	60	120	3 LAMPADE DA 21 WAT= 63 3 LIGHT 21 WAT= 63

### ELEMENTO AD ANGOLO CORNER UNIT MODULE



COLOR	H	P	L
A	112	60	60
G	112	60	60

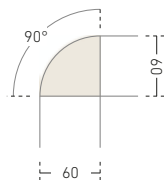

### ELEMENTO AD ANGOLO 45° CORNER UNIT ELEMENT 45°

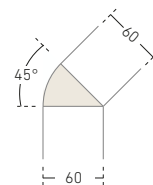

# BANCO CASSA RECEPTION / RECEPTION COUNTER

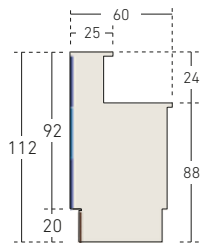
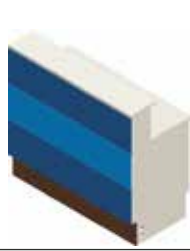

## ELEMENTI H 112 CON ALZATA MODULE H 112 WITH RISER

**ELEMENTO CON VANI**  
MODULE WITH SHELVES



COLOR	H	P	L
A	112	60	40
G	112	60	40



COLOR	H	P	L
A	112	60	80
G	112	60	80

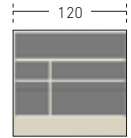

COLOR	H	P	L
A	112	60	120
G	112	60	120

**ELEMENTO CON ANTE**  
MODULE WITH DOORS



COLOR	H	P	L
A	112	60	40
G	112	60	40



COLOR	H	P	L
A	112	60	80
G	112	60	80

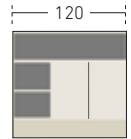

COLOR	H	P	L
A	112	60	120
G	112	60	120

**ELEMENTO CON CASSETTI**  
MODULE WITH DRAWERS



COLOR	H	P	L
A	112	60	40
G	112	60	40



COLOR	H	P	L
A	112	60	80
G	112	60	80

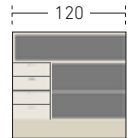

COLOR	H	P	L
A	112	60	120
G	112	60	120

**ELEMENTO CON PEDANA**  
MODULE WITH FOOTBOARD



COLOR	H	P	L
A	112	60	80
G	112	60	80

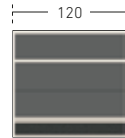

COLOR	H	P	L
A	112	60	120
G	112	60	120

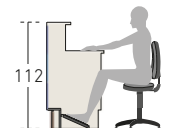

**ELEMENTO CON CASSETTI ED ANTE**  
MODULE WITH DRAWER AND DOORS

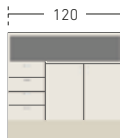

COLOR	H	P	L
A	112	60	120
G	112	60	120

**ELEMENTO AD ANGOLO 90°**  
90° CORNER UNIT MODULE



COLOR	H	P	L
A	112	60	60
G	112	60	60

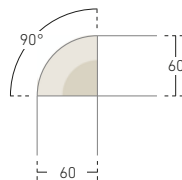

**ELEMENTO AD ANGOLO 45°**  
CORNER UNIT ELEMENT 45°



COLOR	H	P	L
A	112	60	60
G	112	60	60

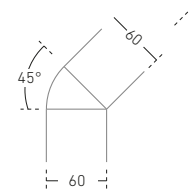

# BANCO CASSA RECEPTION / RECEPTION COUNTER

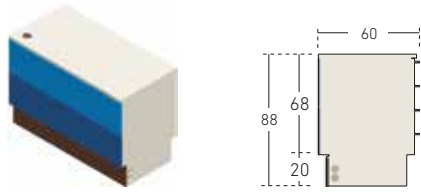

## ELEMENTI H 88 MODULE H 88

### ELEMENTO CON VANI MODULE WITH SHELVES



COLOR	H	P	L
A	88	60	40
G	88	60	40

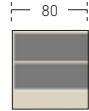

COLOR	H	P	L
A	88	60	80
G	88	60	80

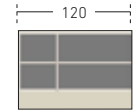

COLOR	H	P	L
A	88	60	120
G	88	60	120

### ELEMENTO CON ANTE MODULE WITH DOORS



COLOR	H	P	L
A	88	60	40
G	88	60	40

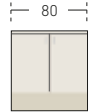

COLOR	H	P	L
A	88	60	80
G	88	60	80

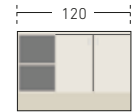

COLOR	H	P	L
A	88	60	120
G	88	60	120

### ELEMENTO CON CASSETTI MODULE WITH DRAWERS



COLOR	H	P	L
A	88	60	40
G	88	60	40

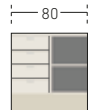

COLOR	H	P	L
A	88	60	80
G	88	60	80

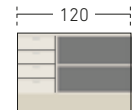

COLOR	H	P	L
A	88	60	120
G	88	60	120

### ELEMENTO CON PEDANA MODULE WITH FOOTBOARD

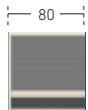

COLOR	H	P	L
A	88	60	80
G	88	60	80

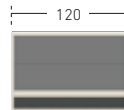

COLOR	H	P	L
A	88	60	120
G	88	60	120

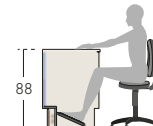

### ELEMENTO CON CASSETTI ED ANTE MODULE WITH DRAWER AND DOORS

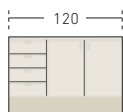

COLOR	H	P	L
A	88	60	120
G	88	60	120

### ELEMENTO CON CASSETTO PER CHIODI ANTITACHEGGIO MODULE WITH NAILS SHOPLIFTING DRAWER

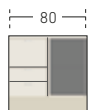

COLOR	H	P	L
A	88	60	80
G	88	60	80

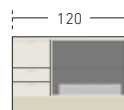

COLOR	H	P	L
A	88	60	120
G	88	60	120

### ELEMENTO CON VETRINA ILLUMINATA MODULE WITH GLASS DISPLAY LIGHTED

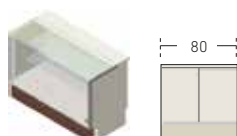

COLOR	H	P	L
A	88	60	80
G	88	60	80

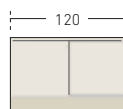

COLOR	H	P	L
A	88	60	120
G	88	60	120

### VETRINA H88: POTENZA ASSORBITA POWER CONSUMPTION

H	P	L	WATT
88	60	80	2 LAMPADE DA 13 WATT + 1 DA 14 WATT = 40 2 LIGHT 13 WATT + 1 LIGHT 14 WATT = 40
88	60	120	2 LAMPADE DA 13 WATT + 1 DA 21 WATT = 47 2 LIGHT 13 WATT + 1 LIGHT 21 WATT = 47

# BANCO CASSA RECEPTION / RECEPTION COUNTER

**ELEMENTO AD ANGOLO 90°**  
CORNER UNIT MODULE 90°



H	P	L
88	60	60
88	60	60

**ELEMENTO AD ANGOLO 45°**  
CORNER UNIT MODULE 45°

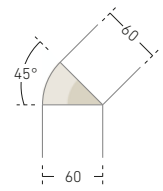
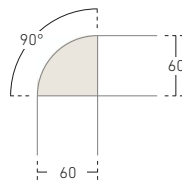

H	P	L
112	60	60
112	60	60

## BANCO CASSA RECEPTION COLORI DISPONIBILI RECEPTION COUNTER AVAILABLE COLOURS

**COLORE STRUTTURA**  
STRUCTURE COLOUR

**STRUTTURA: NOBILITATO GRIGIO (G) PANTONE 425 M**  
STRUCTURE: MELAMINE GREY (G) PANTONE 425 M

**STRUTTURA: NOBILITATO AVORIO (A)**  
STRUCTURE: MELAMINE IVORY (A)

**MICACED**  
ANTHRACITE

**COLORE FRONTE**  
FRONT PANEL COLOUR

RAL 1028	RAL 1017*	RAL 6019*
RAL 3020	RAL 1023*	RAL 6027*
RAL 5002	RAL 2004*	RAL 6029*
RAL 6018	RAL 3000*	RAL 7016*
RAL 9003	RAL 3003*	RAL 7035*
ALLUMINIO ALUMINIUM	RAL 5000*	RAL 9007*
	RAL 5015*	



**COLORI FISSI**  
FIX COLOURS



**COLORI A SCELTA**  
DA SPECIFICARE IN FASE DI ORDINE

COLOR TO BE DEFINED  
AT THE ORDER CONFIRMATION

**\*COLORI CON ADDEBITO FISSO**  
DI € 200,00 PER OGNI ORDINE

**\*COLOURS WITH FIX-OVERCHARGE**  
OF € 200.00 FOR EACH ORDER

# DESK - INFORMAZIONI / INFORMATION DESK

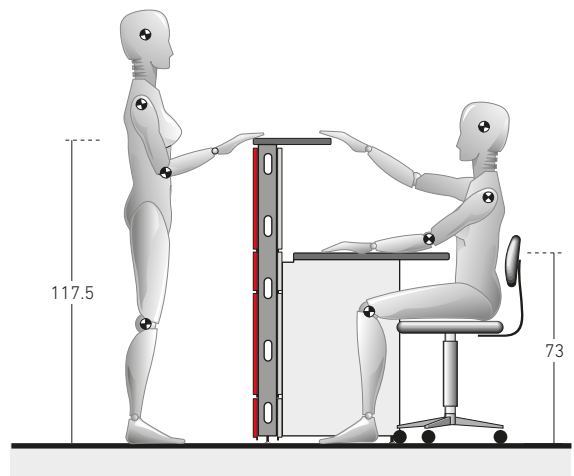
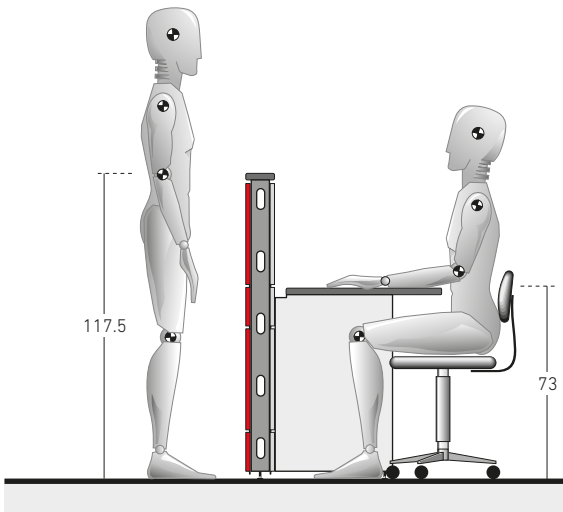
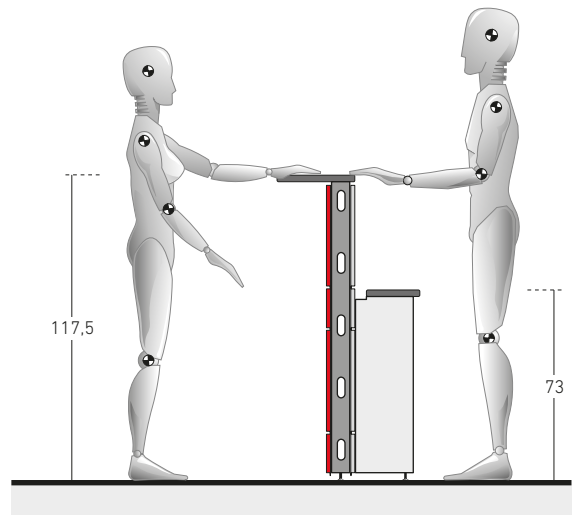
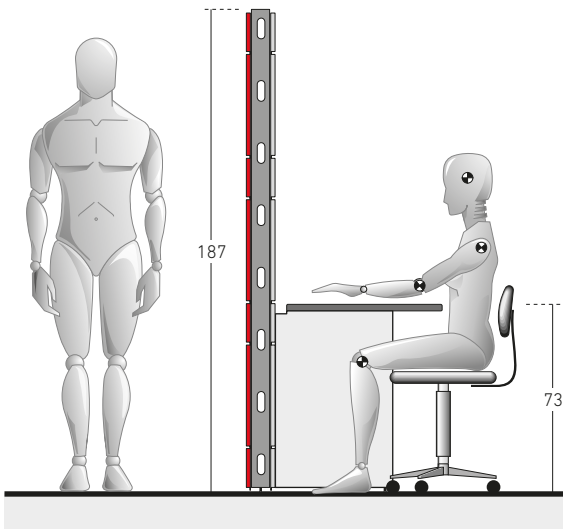



## DESK - INFORMAZIONI / INFORMATION - DESK



GLI INTERNI SONO EFFICIENTI E CONFORTEVOLI.  
AMPIE SCRIVANIE, PIANI D'APPOGGIO, RIPIANI PER LE PARETI ALTE, PORTAOGGETTI.  
LE SCRIVANIE SONO LEGGERMENTE STACCATE DALLA STRUTTURA PER PERMETTERE IL PASSAGGIO DI CAVI E PRESE.

THE INSIDE IS VERY COMFORTABLE AND EFFICIENT.  
WIDE TABLES, WORKING SURFACE, SHELVES FOR HIGH WALLS, OBJECTS HOLDER.  
THE TABLES ARE SLIGHTLY MOVED AWAY FROM THE WALL TO LET THE CABLES AND OUTLETS PASS THROUGH.



LE DIMENSIONI POSSONO ESSERE LE PIÙ VARIE.  
DA SEMPLICI POSTAZIONI PER INFORMAZIONI ALLA CLIENTELA AD UFFICI COMPLETI  
PER IL CONTATTO CON IL PUBBLICO E PER IL LAVORO INTERNO. LE PARETI INFATTI  
HANNO TRE POSSIBILITÀ DI ALTEZZA: 77 CM, 117 CM  
E 187 CM.



IT CAN BE BUILT IN DIFFERENT SIZES.  
SIMPLE INFORMATION BOX, COMPLETE OFFICES FOR THE CUSTOMERS' RELATIONSHIPS  
AND FOR THE INTERNAL WORK. THE WALLS CAN HAVE 3 DIFFERENT HEIGHTS:  
77 CM, 117 CM AND 187 CM.

## DESK - INFORMAZIONI / INFORMATION - DESK



ESTREMAMENTE IMPORTANTI PER LA FUNZIONALITÀ DI DESK SONO LE CANALIZZAZIONI DEI CAVI PER LA STRUMENTAZIONE INTERNA E LA POSSIBILITÀ DI ACCESSORIAMENTO ESTERNO PER I SERVIZI DI INFORMAZIONE E PUBBLICITÀ NEI CONFRONTI DELLA CLIENTELA.

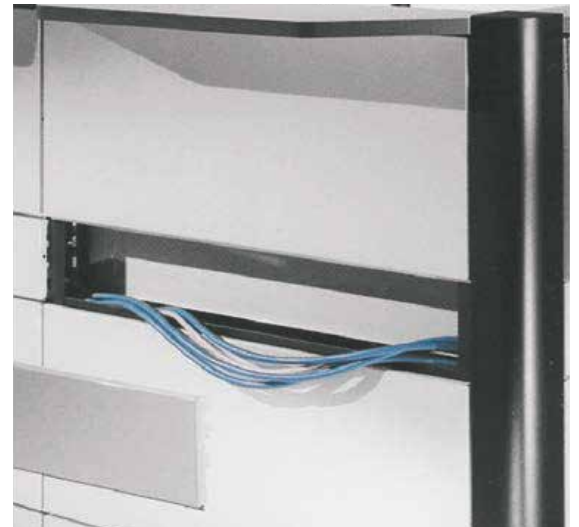

EXTREMELY IMPORTANT FOR THE FUNCTIONALITY OF DESK ARE THE CABLE PASSAGES FOR THE INSIDE EQUIPMENT AND THE WIDE RANGE OF ACCESSORIES FOR THE INFORMATION AND ADVERTISING FOR CUSTOMERS.



DESK È UN SISTEMA DI ARREDAMENTO MODULARE COMPLETO PER TUTTI I SERVIZI CHE NECESSITANO ALL'AREA CASSA.  
DESK È UNICO NEL SUO GENERE E RAPPRESENTA IL COMPLETAMENTO NECESSARIO ALL'OBIETTIVO CHE SCS SI È DATA: ARREDARE COMPLETAMENTE L'AREA CASSE DI QUALSIASI PUNTO VENDITA A LIBERO SERVIZIO.



DESK IS A COMPLETE MODULAR FURNISHING SYSTEM FOR ALL THOSE SERVICES NECESSARY AT THE CHECKOUT-AREA.  
DESK IS THE ONLY ONE OF ITS KIND AND REPRESENT THE ELEMENT NECESSARY FOR SCS'S TARGET: TO FURNISH THE CHECKOUT-AREA IN EACH SELF-SERVICE POINT OF SALE COMPLETELY.

# DESK - INFORMAZIONI / INFORMATION DESK CONFIGURAZIONI PRINCIPALI / MAIN CONFIGURATIONS

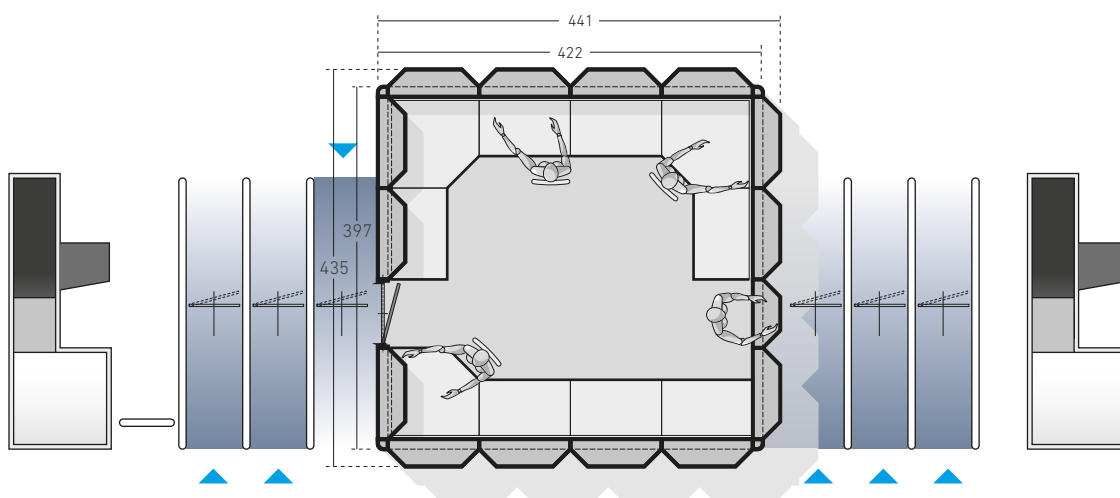
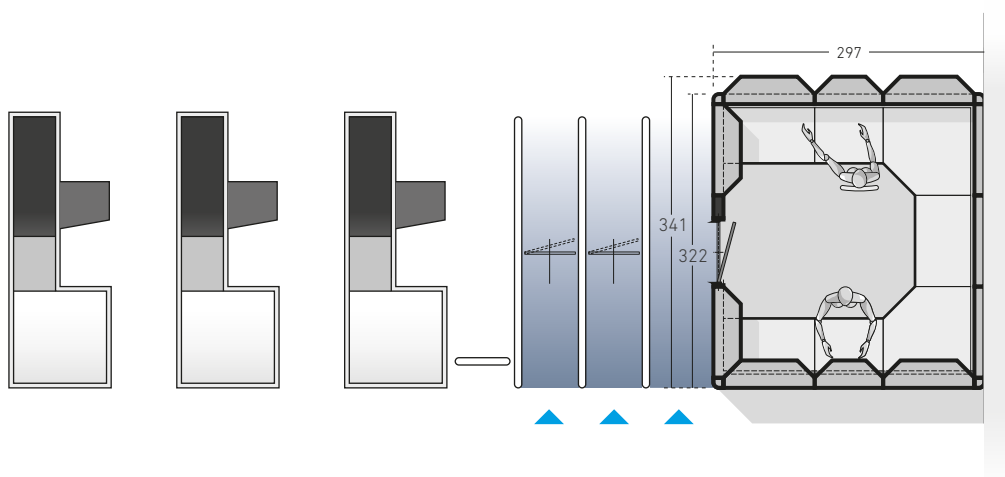
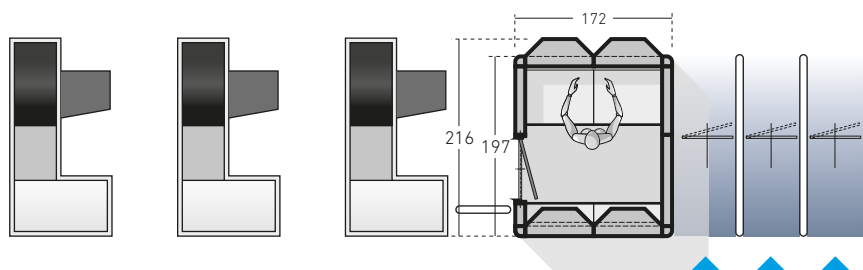

# DESK - INFORMAZIONI / INFORMATION DESK

## CANALIZZAZIONI IMPIANTO ELETTRICO / ELECTRICAL SYSTEM WIRING

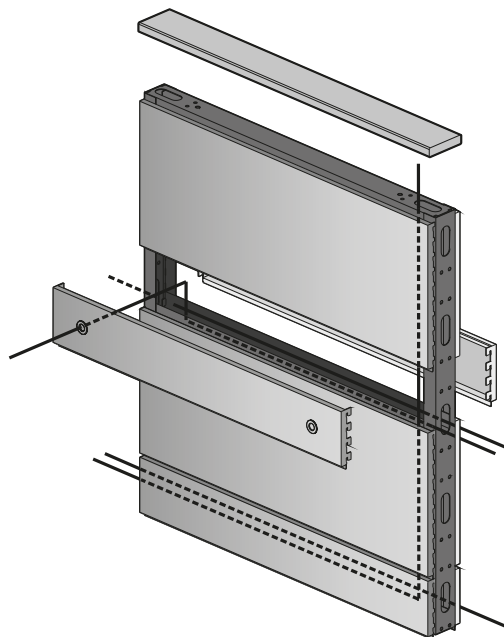
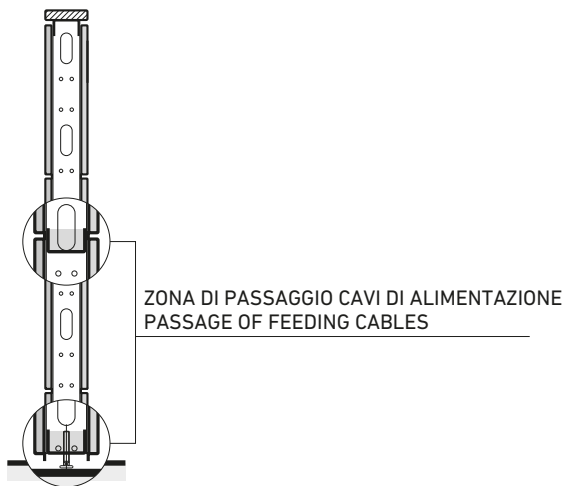

### AVVERTENZE PER IL MONTAGGIO E L'UTILIZZO

- 1) LE EVENTUALI PEDANE NON VENGONO MAI FORNITE DALLA DITTA. PER LA LORO COSTRUZIONE E SUCCESSIVO ANCORAGGIO ALLA STRUTTURA, UTILIZZARE ESCLUSIVAMENTE UNA DELLE SEGUENTI ALTEZZE: H 8,0 CM MIN - H 12,0 CM - H 16,0 CM MAX.
- 2) LA STATICA DI DESK È ASSICURATA DALLA PRESENZA DI SCRIVANIE O PIANI D'APPOGGIO. E' ASSOLUTAMENTE SCONSIGLIATO PROGETTARE ESCLUDENDO SCRIVANIE O PIANI D'APPOGGIO ( IN CASO DI DUBBIO CONSULTARE I NOSTRI TECNICI).
- 3) NELLA PROGETTAZIONE DI DESK FARE ATTENZIONE A NON ANCORARE MAI LE PORTE SU PARETI NON DOTATE DI SCRIVANIE O PIANI D'APPOGGIO. VEDI ESEMPLI.

### INSTRUCTIONS FOR THE INSTALLATION AND THE USE

- 1) NO PLATFORM WILL BE SUPPLIED BY THE COMPANY. FOR ITS CONSTRUCTION AND ITS FIXING TO THE STRUCTURE WE RECOMMEND YOU TO USE ONLY ONE OF THE FOLLOWING HEIGHTS: MIN. 8,0 CM - 12,0 CM - MAX. 16,0 CM.
- 2) THE STABILITY OF DESK IS ASSURED BY THE WRITING-DESKS OR THE SUPPORTING PLATES. NO PROJECT WITHOUT WRITING-DESKS OR SUPPORTING PLATES (CONSULT OUR TECHNICIANS FOR POSSIBLE DOUBTS).
- 3) WHILE PROJECTING, PAY ATTENTION THAT THE DOORS HAVE TO BE FIXED TO THOSE WALLS EQUIPPED WITH WRITING-DESKS AND SUPPORTING PLATES. SEE EXAMPLES.

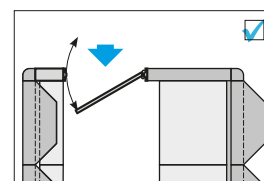
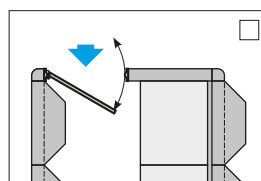
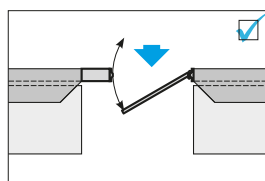
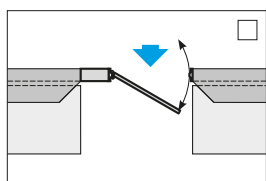

POSSIBILE / POSSIBLE SOLUTION

NON POSSIBILE / NON POSSIBLE SOLUTION

# DESK-INFORMAZIONI - COLORI DISPONIBILI

## INFORMATION DESK - AVAILABLE COLOURS

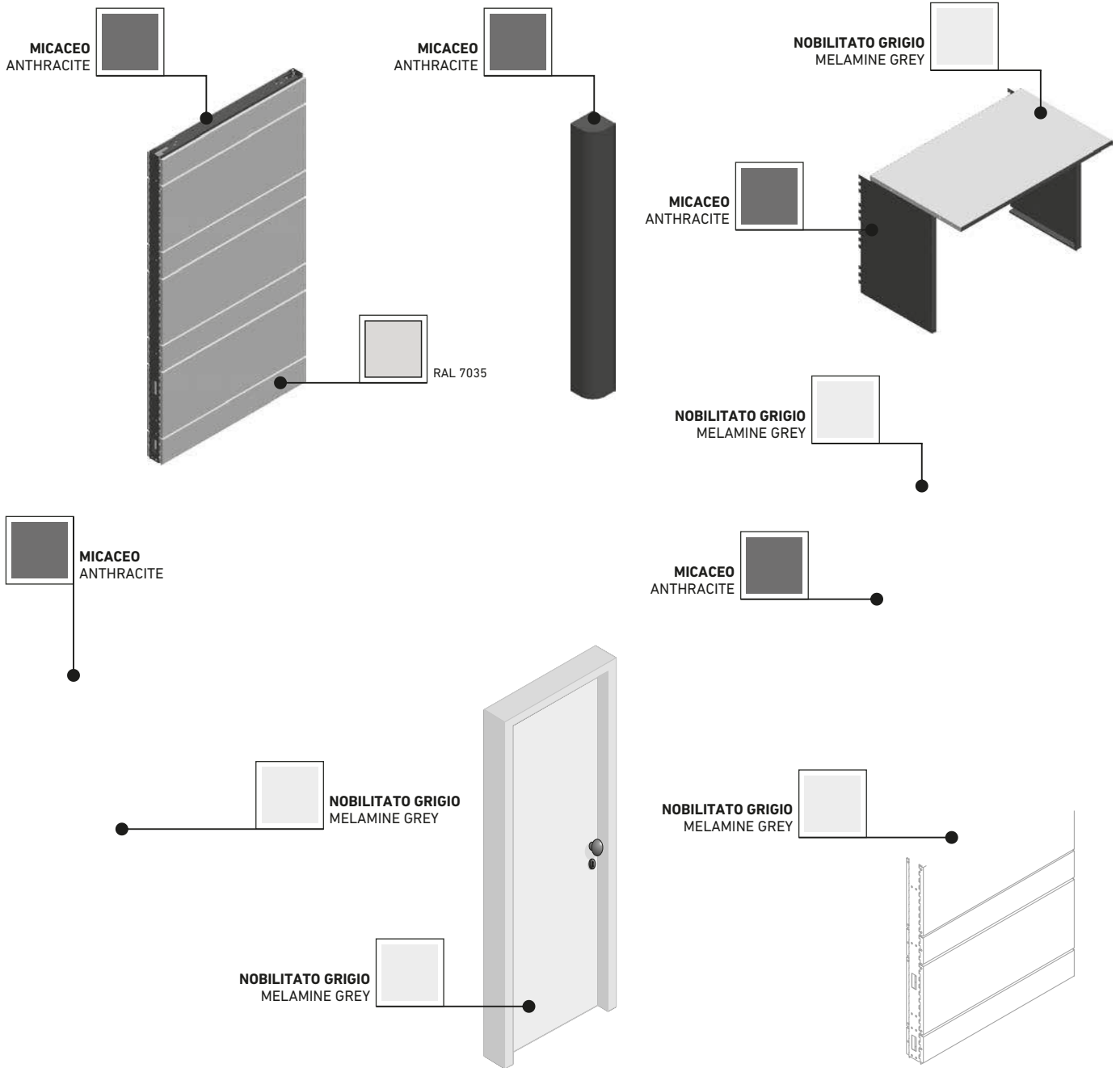

## COLORI DISPONIBILI SU RICHIESTA

### AVAILABLE COLOURS ON DEMAND

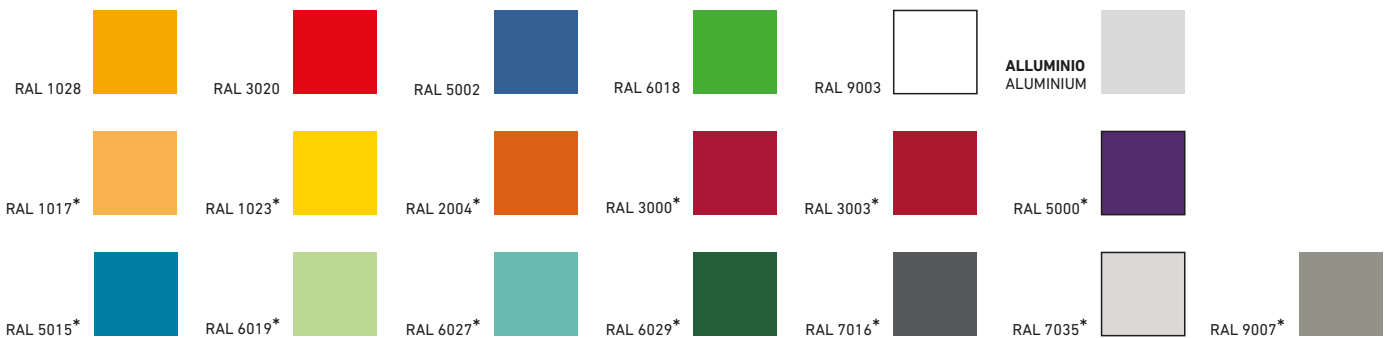

**COLORI FISSI**  
FIX COLOURS



**COLORI A SCELTA DA SPECIFICARE IN FASE DI ORDINE**  
COLOR TO BE DEFINED AT THE ORDER CONFIRMATION

**\*COLORI CON ADDEBITO FISSO DI € 200,00 PER OGNI ORDINE**

**\*COLOURS WITH FIX-OVERCHARGE OF € 200.00 FOR EACH ORDER**

## **SCS srl**

Via Aspio, 2 - 61030  
Lucrezia di Cartoceto (PU) Italy  
Tel. +39 0721 876015  
Fax +39 0721 876014  
[www.scsweb.eu](http://www.scsweb.eu)